

WARNING

**ALWAYS MEASURE START WINDING CURRENT ON START-UP!
NORMALLY 2 to 10 AMPS (See Page 5 for Details)
AND
BEFORE A SUSPECT COMPRESSOR IS REMOVED, ALWAYS
CHECK LOCKED ROTOR PULL-DOWN VOLTAGE
(See Page 2 for Details)**

A & B SERIES

**INSTALLATION & SERVICE INSTRUCTIONS
REFRIGERATION/AIR CONDITIONING/HEAT PUMP COMPRESSORS**

Bristol 
compressors

CAUTION: Bristol compressors are completely interchangeable with other manufacturers. However, electrical specifications, tubing configurations, and wiring connections may vary. Before installing and starting this compressor, you must review the wiring diagrams and check for correct electrical components.

**BRISTOL COMPRESSORS, INC.
BRISTOL, VIRGINIA 24202
(276) 466-4121
FAX (276) 645-2423**

WARNING: Read all procedures and warnings prior to performing maintenance! For your safety, it is essential that you use properly sized and operating test equipment.

WARNING: Air conditioning and refrigeration systems are pressurized; hazards could exist resulting in personal injury. It is therefore recommended that the following steps for troubleshooting, removal and installation of the hermetic compressor be performed by qualified experienced personnel only.

INSTALLATION PROCEDURES AFTER COMPRESSOR HAS BEEN VERIFIED AS FAULTY...

BEFORE CONDEMNING A SINGLE-PHASE COMPRESSOR THAT FAILS TO START...

1. **Verify all following components are OK:**
 - A. Run capacitor
 - B. Starting components (even if not originally installed, start assist should be tried before going to step 2)
 - C. Contactor
 - D. Winding resistance within manufacturer's specification (**assure compressor is cool to the touch**)
 - E. Compressor not grounded via ohmmeter/Megger, etc.
 - F. Compressor power terminals are tight and secure
 - G. Check for hot spots in system wiring (wire insulation melted, connectors, insulators melted, etc.)
2. **Verify locked rotor pull-down voltage (LRPDV).** Always check **LRPDV** before removing the old or new replacement compressor. If the **LRPDV** reduces the supply voltage to the compressor below the "guaranteed to start" voltage of the compressor (single-phase 230/208 LRPDV is 197v), the power supply must be corrected before removing the compressor.

Procedure to check for **LRPDV**: **Warning! Make sure system is properly grounded before proceeding!**

- A. Connect a voltmeter to the common terminal and run terminal of the compressor.
 - B. Remove the start wire from the compressor and insulate the connector lead wire.
 - C. Terminal cover and retainer **MUST** be installed before applying voltage. (See warning on page 4.)
 - D. Apply voltage to the compressor and measure the voltage as the compressor attempts to start (during locked rotor). If internal overload trips, allow time for reset before continuing.
 - E. If the voltage at the compressor terminals does not pull down below the **LRPDV**, reconnect the start wire and try to start again. If the compressor does not start, proceed to step 3 below.
3. **Direct wiring.** This wiring eliminates all other components and system wiring.
 - A. Hard-wire from a fused disconnect to the **C** and **R** terminals of the compressor
 - B. Wire in a new run capacitor from the **S** terminal to the **R** terminal at the compressor using new wire leads (see page 9 permanent split capacitor-wiring diagram)
 - C. Turn on disconnect, verify LRPDV and measure start winding current (see item 10, page 5)
 - D. If compressor does not start, add a two-wire start assist kit in parallel with the run capacitor and repeat step 3 (C). If the pressures are equalized and the LRPDV and start current are OK, and the compressor still does not start, it is definitely faulty.

WARNING: Never use oxygen to pressurize a refrigeration or air conditioning system. Oxygen can explode on contact with oil and could cause personal injury. When using high pressure gas such as nitrogen or CO₂ for this purpose, be sure to use a regulator that can control the pressure down to 1 or 2 psig.

The following instructions are general in nature but include major points of consideration that will ensure proper installation and protect you from possible personal injury. Please use this as a checklist, taking each item in its order before proceeding to the next. If more information is required, please call Bristol Compressors' Service Department.

1. **VERIFY PROPER APPLICATION.** Verify that the compressor being replaced and the Bristol compressor have a like capacity for the refrigerant being used and that the **voltage** and **frequency** characteristics are the same. Consult your wholesaler if you have any questions about proper compressor application.



WARNING: To avoid electrical shock, power to the compressor should remain off during performance of Steps 2 through 10.

2. **DETERMINE CAUSE OF INITIAL FAILURE.** In order to prevent a second failure, the cause of the original failure must be determined. Identify the cause and make the necessary repairs.
- A. **BEFORE REMOVING THE FAULTY COMPRESSOR:** Remove refrigerant charge using proper recovery procedures. Call 1-800-441-9450 for the name of the nearest Dupont authorized distributor, or 1-800-631-8138 for Genetron Representative or 1-800-ASK-KLEA (ICI) for information on refrigerant reclaim programs.
 - B. Remove the electrical leads from the compressor. Note and label the terminal to which each wire is connected.
 - C. During the next operation, the access ports should be open so that pressure does not build up in the system. Use a high temperature torch to sweat the suction line and the discharge line loose from the compressor.
 - D. Remove the faulty compressor.
 - E. **Assure excessive oil does not remain in the system. Measure oil in the failed compressor and, if oil is low, flush excess from system (or see alternative below).**

Good indicators of excess oil are: violent vibration and/or high **variable** sound as the extra oil moves through the system.

Alternatives: If the excess oil cannot be flushed from the system, the last alternative is to reduce the oil charge in the new compressor by the amount left in the system.

- This procedure should be used only if the following are true:
 - The oil remaining in the system is dry (i.e., system had not leaked down)
 - Oil type is same as in the replacement compressor
 - Compressor failure was not a motor burnout
 - The oil remaining in the system is less than 50% of the original oil charge
 - Suction filter drier must be installed
- Procedure if failed compressor has lost more than 50% of the original oil charge
 - Operate new compressor for 15 minutes in cooling mode (30 minutes if a suction line accumulator is installed)
 - Recover refrigerant and remove the compressor
 - Remove oil from the compressor and recharge with fresh oil per the manufacturer's specifications

- E. Remove the faulty compressor.

CAUTION: The compressor may contain harmful acids — be sure to handle with extreme care using proper protection equipment. After confirming oil charge level, return oil to compressor and install suction and discharge rotalock caps. Copper tube fittings should be brazed closed. This is needed to prevent further contamination of the compressor and to prevent spillage from the compressor.

3. **MOUNT THE NEW COMPRESSOR.** Do not remove dust cover or rubber shipping plugs until all other connections have been completed (i.e., filters installed and all tubing changes made — see steps 4, 5 and 6). Compressor should not be open to the atmosphere for more than 15 minutes. Be sure to use the new mounting grommets that were shipped with the compressor. If the mounting sleeves shipped with the compressor are used, the mounting bolts will bottom out when tight. Use care not to over-compress the mounting grommets when the mounting sleeves cannot be used.

4. **INSTALL FILTER DRIERS.** Bristol Compressors recommends the use of new adequately sized liquid and suction line driers anytime a compressor is replaced. If the new compressor is to be used to replace a compressor with a burned motor, the use of a high acid neutralizing filter drier is recommended. **For heat pumps, a suction filter drier must be installed between the accumulator and the compressor suction**

inlet. In addition, a bi-directional heat pump liquid line drier or factory recommended driers must be installed. NOTE: ALWAYS REMOVE OLD FILTER DRIERS.

5. **BRAZE ON SUCTION AND DISCHARGE LINES.** Flow an inert gas, such as nitrogen or CO₂, through the system at approximately 2 psig. This will reduce the possibility of oxidation inside the tubing. Braze on the suction and discharge lines and braze the process tube shut following the recommendation listed below (if the process tube is to be used, it should be brazed shut after the system has been charged):

COPPER TUBING: If additional copper tubing is required, use only clean, dehydrated refrigeration grade tubing with sealed ends.

BRAZING ALLOYS: **CAUTION: Do not use 95/5, 50/50 or 40/60 soft solder for brazing.** Use Sil-Fos or Phos Copper, or similar brazing alloys with high tensile strength on copper welds only. Weld steel to copper only with silver brazing alloys.

BRAZING PROCEDURE: To ensure properly brazed joints, Bristol Compressors recommends that the following steps be used:

- a. Exercise extreme care when cutting and forming tubes to keep dirt, filings, and other contaminants from entering the system.
- b. Do not use excessive amounts of brazing alloy as some of the excess may penetrate the joint and enter the system.
- c. If flux must be used, take necessary precautions to ensure that the flux does not enter the system.
- d. Use damp cloths or other heat absorbent material to ensure that the factory-brazed joints on the compressor do not become damaged. If damp cloths are used, take care not to allow moisture to enter the system.
- e. Do not overheat brazed joints as excess heat will cause formation of copper oxide on the inside wall of the tubing. Flow an inert gas through the system, as explained above.

6. **CHECK SYSTEM FOR LEAKS.** After installation is complete, pressurize the system to 75 psig using nitrogen and a few ounces of system refrigerant. Check for leaks using a halide torch, soap bubbles or an electronic halogen leak detector. When all connections test satisfactorily, release pressure using proper recovery procedures, then proceed to next step.

CAUTION: Do not use the Bristol replacement compressor as an evacuation assist and never apply voltage to a compressor while it is in a vacuum as damage could result.

7. **EVACUATE THE SYSTEM.** Use a vacuum pump designed for this purpose. Vacuum must be pulled on the discharge (high side) and suction (low side) of the system. Evacuate to 200 microns or lower.

8. **CHECK THE ELECTRICAL SYSTEM.** While the system is evacuating, connect the electrical leads to the compressor terminals. Verify that the electrical system is wired according to the unit's manufacturer and Bristol's wiring diagram on page 9. Verify that the electrical components match those specified on the compressor electrical data sheet on pages 10 through 14. **Start components (start capacitor and relay) are required on all systems that incorporate a hard shut-off or non-bleed thermostatic expansion valve.** It is a normal practice to replace all starting components any time a compressor is changed. Check all connections and terminals to be sure they are tight. Connect the crankcase heater (standard on all "A" Series). **Power to the crankcase heater must be energized continuously.** Voltage to an insertion type heater can be anything between 187 to 600 volts. Operational voltage for wrap-around type heaters must be verified.

WARNING: Application of voltage to the compressor with the terminal cover and retainer removed can result in serious personal injury or death.

9. **CHARGE THE SYSTEM.** When a vacuum of at least 200 microns is reached, close gauge valve, remove vacuum pump, and break the vacuum using system refrigerant vapor. Never dump liquid refrigerant into the compressor. Liquid can be used to break the vacuum if it is connected to the liquid line, not the discharge line.

Charge the system according to the manufacturer's specifications. Be sure to compensate the charge for the addition of the filter drier. Consult unit pressure/superheat chart on the unit door panel for the correct superheat since pressures and superheat change with the ambient temperature.

WEIGHING in the system charge to the factory specification will help point out system faults that may still exist.

10. **START-UP. CLAMP-ON AMMETER MUST BE IN PLACE BEFORE POWER IS APPLIED TO MONITOR START WINDING CURRENT ON START-UP!!** See page 6

ASSURE THESE NORMAL START WINDING CURRENTS ON START-UP

<u>CONFIGURATION</u>	<u>APPROX. CURRENT</u>
NORMAL START WITH RUN CAP ONLY	2 - 10 AMPS
NORMAL START WITH RUN AND START CAP	20 AMPS AND DROP TO 2-10 AFTER START
NORMAL START WITH START CAP (INDUCTION RUN)	20 AMPS AND DROP TO 0 AFTER START

WARNING: If above currents are exceeded for more than 5 seconds, disconnect power and correct the fault before restarting.

NOTE: Assure voltage to compressor does not drop below minimum allowable voltage (eg. 197 volts for 230/208-1-60) during the period the compressor is trying to start. Refer to page 2 for explanation of test to check LOCKED ROTOR PULL-DOWN VOLTAGE.

FOR CAPACITOR START/CAPACITOR RUN (CSR) MODELS

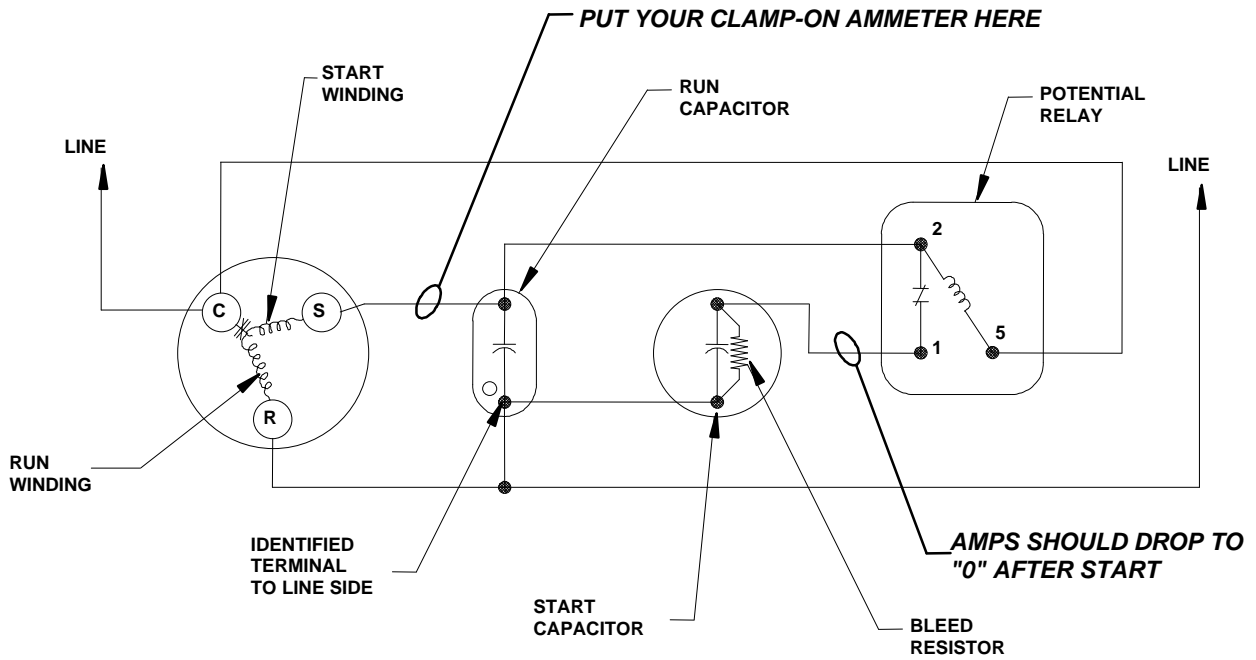

FOR CAPACITOR START INDUCTION RUN (CSIR) MODELS

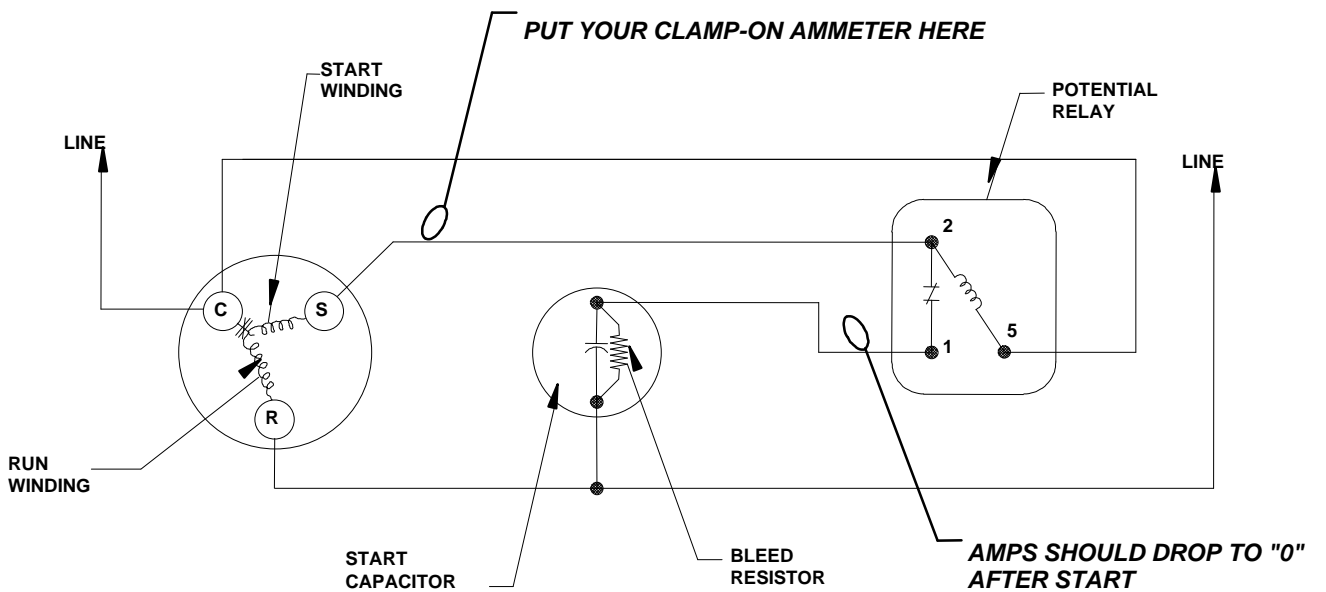

□ 11. **VERIFY SYSTEM WILL NOT ALLOW LIQUID FLOODBACK.**

HEAT PUMP

STEP 1: Operate system in the heating mode with outdoor fan disconnected.

STEP 2: Run system until the designed winter condition in your area is reached (may need to cover coil for this test).

STEP 3: Check suction superheat 6" from compressor inlet.

STEP 4: Superheat should not drop below 5°F (3°K) (prefer no lower than 10°F [6°K]).

STEP 5: Sump temperature should always be 50°F (28°C) or higher above saturated suction temperature.

EXAMPLE: "R-22"

$$\begin{aligned} 38 \text{ psig} &= 16^\circ\text{F} (-9^\circ\text{C}) &&= \text{SATURATED SUCTION} \\ &+ 50^\circ\text{F} (28^\circ\text{K}) &&= \text{MINIMUM TEMP. DIFFERENCE} \\ &66^\circ\text{F} (19^\circ\text{C}) &&= \text{MINIMUM SUMP TEMPERATURE} \end{aligned}$$

COOLING MODE (HEAT PUMP)

STEP 1: Operate system in cooling mode with indoor fan disconnected and repeat steps 3, 4 and 5.

AIR-CONDITIONING/REFRIGERATION UNITS

STEP 1: Operate system in the cooling mode with indoor fan disconnected and repeat steps 3, 4 and 5.

HOW TO CHECK SUPERHEAT

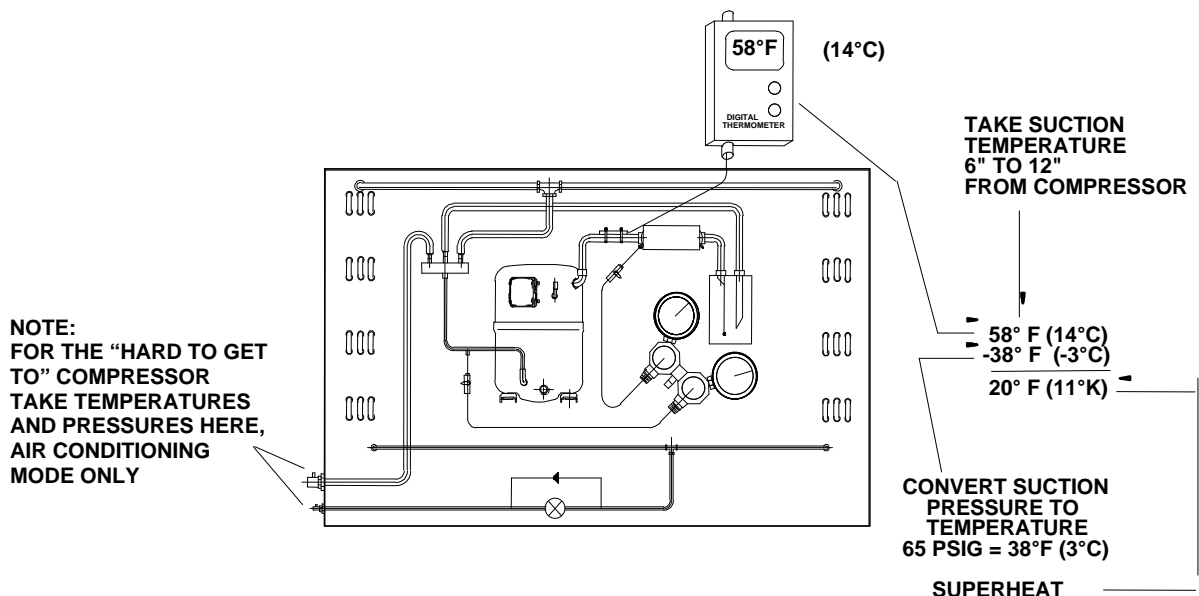

□ 12. **CHECK FILTER DRIERS FOR CONTAMINATION.**

- A. **Suction Line Filter:** If internal contamination is heavy, the suction line filter drier may become clogged and ineffective. Check the pressure drop across the filter drier after approximately 8 hours running time and, if it exceeds 2 psig, replace.

- B. **Liquid Line Filter:** Always replace the original equipment liquid line filter drier(s). If the OEM liquid line drier(s) is not removed from the system, a restriction most likely will result. A slight restriction in this filter will reduce the efficiency of the system. A large restriction will cause the suction pressure and discharge pressure to be reduced. This reduction in pressure will occur only with a properly charged system (i.e., refrigerant weighed in to the OEM specifications). An over-charged system will increase pressures when there is a restriction in the liquid line. The service person tends to add more charge to the system to increase the suction pressure. Normally, any charge added above the OEM specifications will increase the suction pressure due to the discharge pressure increasing but in the case of a restriction, charge can be added to a point the system shuts down on the high pressure limit switch. The service person may not see the higher discharge pressure due to his service port being in the liquid line which is normally downstream from the liquid line filter drier in residential split systems. A pressure port installed in the hot gas discharge line just as it exits the compressor is required to see true discharge pressure.
- C. **Discharge Line Filter:** Some OEM equipment may have a filter in the hot gas line (6" – 12" from compressor). Checks outlined in (B) above apply.

IMPORTANT: The compressor has an internal relief valve (IPRV) that is designed to open if the system is subjected to a high pressure situation. Example causes are: overcharged, air in system, restriction, factory-installed metering device screens not removed and cleaned, old liquid line filter left in the system, poor airflow across the condenser, condenser fan failure, poor airflow across the evaporator in the heating mode (dirty return air filter(s)), poor system design (duct system undersized), etc. The IPRV will open when the discharge pressure exceeds the suction pressure by more than 450 psi ("B" products) or 400 psi ("A" products). If the relief valve opens, a high velocity gas flow may be heard inside the compressor housing. In some cases, the relief valve may open so quickly due to a restriction in the system, the high pressure will be difficult to observe on standard gauges. In most instances, if the service person installs a discharge service gauge on the discharge line just as it exits the compressor, the development of high pressure can be observed before the relief valve opens. Installing the discharge service gauge on the liquid line outside the system may not detect a restriction. To reset the relief valve, shut the compressor off for at least 5 minutes, allowing pressures to equalize.



REVIEW ALL TWELVE STEPS TO MAKE SURE NOTHING WAS OVERLOOKED.

START ASSIST WIRING DIAGRAM (START AND RUN CAPACITORS):

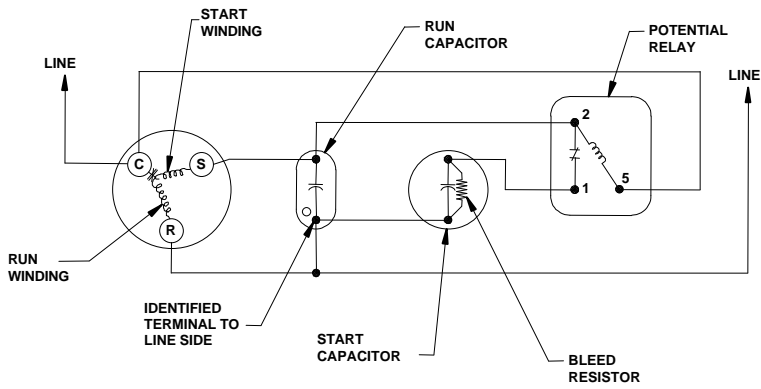

Use this diagram on systems with expansion valve and systems that do not allow pressure equalization prior to compressor start.

NOTE: WHEN CRANKCASE HEATER IS USED, CONNECT TO INCOMING POWER LINE SO THAT HEATER IS ENERGIZED CONTINUOUSLY.

PERMANENT SPLIT CAPACITOR (PSC) WIRING DIAGRAM:

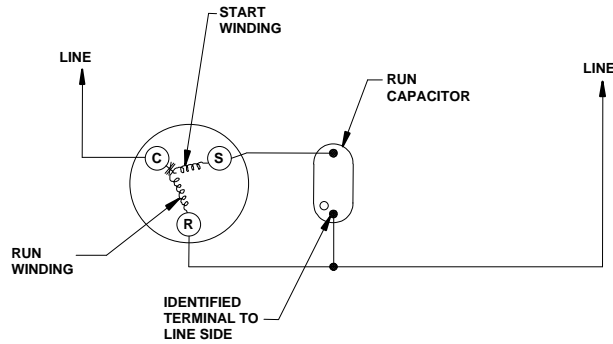

Use this diagram on systems that allow pressure equalization prior to compressor start.

NOTE: WHEN CRANKCASE HEATER IS USED, CONNECT TO INCOMING POWER LINE SO THAT HEATER IS ENERGIZED CONTINUOUSLY.

START ASSIST WIRING DIAGRAM (PTCR AND RUN CAPACITOR):

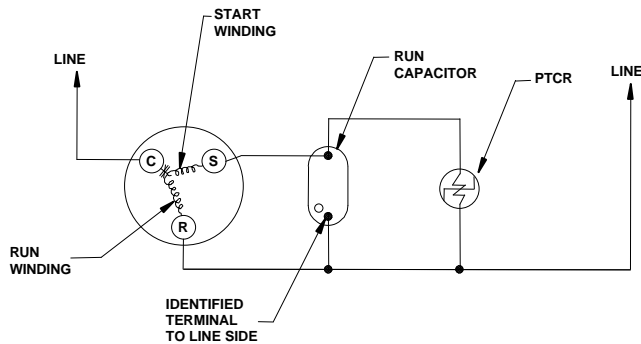

Use this light start assist in case of a slight low voltage condition with equalized pressures prior to compressor start.

NOTE: SOFT START ASSIST (PTCR) IS REQUIRED ON SOME HIGH EFFICIENCY COMPRESSORS (SEE PAGE 12) EVEN WHEN THE SYSTEM EQUALIZES. "C" IN THE 8TH-DIGIT OF MODEL NUMBER IDENTIFIES COMPRESSORS THAT REQUIRE PTCR START ASSIST. NOT REQUIRED WHEN A START ASSIST KIT IS USED (RELAY, START CAPACITOR).

AIR CONDITIONING & HEAT PUMP ELECTRICAL COMPONENTS PARTS FOR SINGLE PHASE COMPRESSORS

H24B SERIES 60 HZ

Compressor Model Number	Voltage Phase Hz	Capacitors		Potential Relays			PTCR Starter
		Run μ fd/Volts	Start μ fd/Volts	GE 3ARR3	Mars		
					6-Pak	OEM	
H24B13QABCA	230/208-1-60	15/370	88-108/250	3U	66	16049	Optional
H24B13QABCB	230/208-1-60	15/370	88-108/250	3U	66	16049	Optional

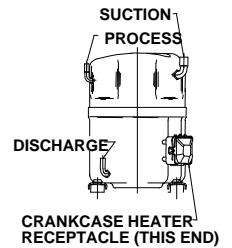

H23B

H23B SERIES 60 HZ

Compressor Model Number	Voltage Phase Hz	Capacitors		Potential Relays			PTCR Starter
		Run μ fd/Volts	Start μ fd/Volts	GE 3ARR3	Mars		
					6-Pak	OEM	
H23B15QABC	230/208-1-60	25/370	88-108/250	3T	69	16068	Optional
H23B15QABH	265-1-60	20/440	88-108/330	10T	69	16073	Optional
H23B17QABC	230/208-1-60	25/370	88-108/250	3P	65	16050	Optional
H23B17QABH	265-1-60	25/370	88-108/330	10U	NA	NA	Optional
H23B19QABC	230/208-1-60	25/370	88-108/250	10S	69	16067	Optional
H23B20QABC	230/208-1-60	25/370	88-108/250	10S	69	16067	Optional
H23B22QABC	230/208-1-60	30/370	88-108/250	10S	69	16067	Optional
H23B22QABH	265-1-60	25/440	88-108/250	25U	66	NA	Optional
H23B24QABC	230/208-1-60	35/370	88-108/250	24P	69	16072	Optional
H23B26QABC	230/208-1-60	35/370	88-108/250	3P	65	16050	Optional
H23B28QABC	230/208-1-60	35/370	88-108/250	10S	69	16067	Optional
H23B28QABH	265-1-60	30/440	88-108/330	10S	69	16067	Optional
H23B30QABC	230/208-1-60	40/370	88-108/250	24P	69	16072	Optional
H23B32QABC	230/208-1-60	45/370	88-108/250	3L	NA	16083	Optional

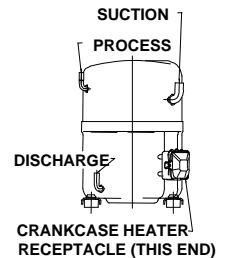

H24B, H29B

H29B SERIES 60 HZ

Compressor Model Number	Voltage Phase Hz	Capacitors		Potential Relays			PTCR Starter
		Run μ fd/Volts	Start μ fd/Volts	GE 3ARR3	Mars		
					6-Pak	OEM	
H29B14UABC	230/208-1-60	30/370	161-193/250	3V	66	16048	Optional
H29B15UABC	230/208-1-60	30/370	161-193/250	3V	66	16048	Optional
H29B16UABC	230/208-1-60	30/370	161-193/250	3V	66	16048	Optional
H29B17UABC	230/208-1-60	30/370	161-193/250	3V	66	16048	Optional
H29B17UABH	265-1-60	25/440	88-108/330	10U	NA	NA	Optional
H29B18UABC	230/208-1-60	30/370	161-193/250	3V	66	16048	Optional
H29B18UABH	265-1-60	25/440	88-108/330	10U	NA	NA	Optional
H29B20UABC	230/208-1-60	30/370	145-175/250	3U	66	16048	Optional
H29B20UABH	265-1-60	30/440	88-108/330	10S	69	16067	Optional
H29B22UABC	230/208-1-60	30/370	145-175/250	3U	66	16049	Optional
H29B22UABH	265-1-60	30/440	88-108/330	10S	69	16067	Optional
H29B24UABC	230/208-1-60	35/370	145-175/250	3T	69	16068	Optional
H29B24UABH	265-1-60	30/440	88-108/330	10S	69	NA	Optional
H29B26UABC	230/208-1-60	35/370	145-175/250	3T	69	16068	Optional
H29B26UABH	265-1-60	30/440	88-108/330	10S	69	NA	Optional
H29B28UABC	230/208-1-60	35/370	145-175/250	3T	69	16068	Optional
H29B28UABH	265-1-60	30/440	88-108/330	10S	69	NA	Optional
H29B30UABC	230/208-1-60	40/370	145-175/250	3P	65	16050	Optional
H29B30UABH	265-1-60	30/440	88-108/330	10S	69	NA	Optional

NOTE: Eleventh character of the model number represents the foot configuration – could be A or B.

AIR CONDITIONING & HEAT PUMP ELECTRICAL COMPONENTS PARTS FOR SINGLE PHASE COMPRESSORS

H29B SERIES 60 HZ (Continued)

Compressor Model Number	Voltage Phase Hz	Capacitors		Potential Relays			PTCR Starter
		Run μ fd/Volts	Start μ fd/Volts	GE 3ARR3	Mars		
					6-Pak	OEM	
H29B32UABC	230/208-1-60	40/370	145-175/250	3P	65	16050	Optional
H29B32UABH	265-1-60	30/440	88-108/330	10S	69	NA	Optional
H29B33UABC	230/208-1-60	45/370	243-292/250	3V	66	16048	Optional
H29B33UABH	265-1-60	30/440	88-108/330	10S	69	NA	Optional
H29B35UABC	230/208-1-60	45/370	145-175/250	3N		16082	Optional
H29B35UABH	265-1-60	35/440	88-108/330	10S	69	NA	Optional

H29A SERIES 60 HZ

Compressor Model Number	Voltage Phase Hz.	Capacitors		Potential Relays			PTCR Starter
		Run μ fd/Volts	Start μ fd/Volts	GE 3ARR3	Mars		
					6-Pak	OEM	
H29A323CBC	230/208-1-60	40/370	270-324/330	3S	NA	16055	305C20
H29A353CBC	230/208-1-60	40/370	270-324/330	3S	NA	16055	305C20
H29A383CBC	230/208-1-60	45/370	270-324/330	3S	NA	16055	305C20
H29A403CBC	230/208-1-60	45/370	270-324/330	3P	NA	16054	305C19
H29A423CBC	230/208-1-60	45/370	270-324/330	3P	NA	16054	305C19
H29A443CBC	230/208-1-60	45/370	270-324/330	3P	NA	16054	305C9
H29A473CBC	230/208-1-60	55/370	270-324/330	3N	NA	16053	305C19
H29A503CBC	230/208-1-60	55/370	270-324/330	3N	NA	16053	305C19
H29A543CBC	230/208-1-60	60/370	270-324/330	3N	NA	16053	305C9
H29A563CBC	230/208-1-60	60/370	270-324/330	3N	NA	16053	305C9
H29A583CBC	230/208-1-60	60/370	270-324/330	24R	NA	16057	305C19
H29A623CBC	230/208-1-60	60/370	270-324/330	24R	NA	16057	305C9

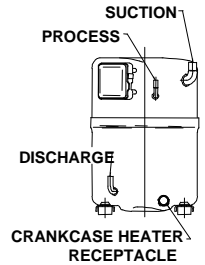

H23A, H29A

H23A SERIES 60 HZ

Compressor Model Number	Voltage Phase Hz.	Capacitors		Potential Relays			PTCR Starter
		Run μ fd/Volts	Start μ fd/Volts	GE 3ARR3	Mars		
					6-Pak	OEM	
H23A353ABC	230/208-1-60	35/440	145-175/250	4A	64	16047	Optional
H23A383ABC	230/208-1-60	35/440	145-175/250	4A	64	16047	Optional
H23A423ABC	230/208-1-60	40/440	145-175/250	4A	64	16047	Optional
H23A463ABC	230/208-1-60	40/440	135-155/330	4A	64	16047	Optional
H23A503ABC	230/208-1-60	40/440	135-155/330	4A	64	16047	Optional
H23A543ABC	230/208-1-60	45/440	135-155/330	4A	64	16047	Optional
H23A563ABC	230/208-1-60	55/440	135-155/330	6U	66	16062	Optional
H23A623ABC	230/208-1-60	55/440	135-155/330	4A	64	16047	Optional

H24A SERIES 50 HZ

Compressor Model Number	Voltage Phase Hz.	Capacitors		Potential Relays			PTCR Starter
		Run μ fd/Volts	Start μ fd/Volts	GE 3ARR3	Mars		
					6-Pak	OEM	
H24A383ABK	220/240-1-50	40/440	145-175/330	4AA	NA	NA	Optional
H24A423ABK	220/240-1-50	40/440	145-175/330	4AA	NA	NA	Optional

H24B SERIES 50 HZ

Compressor Model Number	Voltage Phase Hz.	Capacitors		Potential Relays			
		Run μ fd/Volts	Start μ fd/Volts	GE 3ARR3	Mars		PTCR Starter
					6-Pak	OEM	
H24B15QABH	220/240-1-50	20/370	88-108/250	10AT	NA	NA	Optional
H24B17QABH	220/240-1-50	25/370	88-108/250	10AT	NA	NA	Optional
H24B19QABK	220/240-1-50	25/370	88-108/330	25AS	NA	NA	Optional

H24B SERIES 50 HZ (Continued)

Compressor Model Number	Voltage Phase Hz.	Capacitors		Potential Relays			
		Run μ fd/Volts	Start μ fd/Volts	GE 3ARR3	Mars		PTCR Starter
					6-Pak	OEM	
H24B20QABK	220/240-1-50	25/370	88-108/250	6AW	NA	NA	Optional
H24B22QABH	220/240-1-50	30/370	88-108/250	25AS	NA	NA	Optional
H24B24QABH	220/240-1-50	35/370	88-108/250	25AS	NA	NA	Optional
H24B26QABH	220/240-1-50	35/370	88-108/250	25AS	NA	NA	Optional
H24B28QABH	220/240-1-50	40/370	88-108/250	25AS	NA	NA	Optional
H24B29QABK	220/240-1-50	40/370	88-108/250	24AP	NA	NA	Optional
H24B31QABK	220/240-1-50	45/370	88-108/250	25AS	NA	NA	Optional
H24B32QABK	220/240-1-50	45/440	88-108/250	25AS	NA	NA	Optional

H25B SERIES 50 HZ

Compressor Model Number	Voltage Phase Hz.	Capacitors		Potential Relays			
		Run μ fd/Volts	Start μ fd/Volts	GE 3ARR3	Mars		PTCR Starter
					6-Pak	OEM	
H25B17QABH	220/240-1-50	30/370	145-175/250	10S	69	16067	Optional
H25B18QABH	220/240-1-50	30/370	145-175/250	10S	69	16067	Optional
H25B22QABH	220/240-1-50	30/440	145-175/250	10U	NA	NA	Optional
H25B24QABH	220/240-1-50	35/370	145-175/250	10U	NA	NA	Optional
H25B26QABH	220/240-1-50	40/370	145-175/250	10S	69	16067	Optional
H25B28QABH	220/240-1-50	40/370	145-175/250	10S	69	16067	Optional
H25B30QABH	220/240-1-50	40/370	145-175/250	10S	69	16067	Optional
H25B32QABH	220/240-1-50	40/370	145-175/250	10S	69	16067	Optional
H25B35QABH	220/240-1-50	45/370	145-175/250	10S	69	16067	Optional

H28A SERIES 50 HZ

Compressor Model Number	Voltage Phase Hz.	Capacitors		Potential Relays			
		Run μ fd/Volts	Start μ fd/Volts	GE 3ARR3	Mars		PTCR Starter
					6-Pak	OEM	
H28A383ABK	220/240-1-50	50/370	145-175/250	24P	69	16072	Optional
H28A423ABK	220/240-1-50	55/370	145-175/250	24P	69	16072	Optional
H28A473ABK	220/240-1-50	65/440	161-193/250	6AS	NA	NA	Optional

H29B SERIES 50 HZ

Compressor Model Number	Voltage Phase Hz.	Capacitors		Potential Relays			
		Run μ fd/Volts	Start μ fd/Volts	GE 3ARR3	Mars		PTCR Starter
					6-Pak	OEM	
H29B17UABH	220/240-1-50	30/370	145-175/250	10S	69	16067	Optional
H29B18UABH	220/240-1-50	30/370	145-175/250	10S	69	16067	Optional
H29B20UABH	220/240-1-50	35/370	145-175/250	10U	NA	NA	Optional
H29B22UABH	220/240-1-50	35/370	145-175/250	10U	NA	NA	Optional
H29B24UABH	220/240-1-50	40/370	145-175/250	10S	69	16067	Optional
H29B26UABH	220/240-1-50	40/370	145-175/250	10S	69	16067	Optional
H29B28UABH	220/240-1-50	40/370	145-175/250	3L	NA	16083	Optional
H29B30UABH	220/240-1-50	40/370	145-175/250	10S	69	16067	Optional
H29B32UABH	220/240-1-50	40/370	145-175/250	10S	69	16067	Optional
H29B33UABH	220/240-1-50	40/370	145-175/250	10S	69	16067	Optional
H29B35UABH	220/240-1-50	45/370	145-175/250	10S	69	16067	Optional

H73A SERIES 50 HZ

Compressor Model Number	Voltage Phase Hz.	Capacitors		Potential Relays			
		Run μ fd/Volts	Start μ fd/Volts	GE 3ARR3	Mars		PTCR Starter
					6-Pak	OEM	
H73A263ABH	220/240-1-50	35/370	145-175/250	10AS	NA	NA	Optional
H73A283ABK	220/240-1-50	35/370	145-175/250	10AS	NA	NA	Optional
H73A303ABH	220/240-1-50	35/370	145-175/250	10AS	NA	NA	Optional
H73A323ABH	220/240-1-50	40/370	145-175/250	10AT	NA	NA	Optional
H73A353ABH	220/240-1-50	35/370	145-175/250	25AV	NA	NA	Optional
H73A383ABK	220/240-1-50	35/440	145-175/330	4AA	NA	NA	Optional
H73A423ABK	220/240-1-50	40/440	145-175/330	27AA	NA	NA	Optional
H73A463ABK	220/240-1-50	40/440	145-175/330	4AA	NA	NA	Optional

H23A SERIES 50 HZ

Compressor Model Number	Voltage Phase Hz.	Capacitors		Potential Relays			
		Run μ fd/Volts	Start μ fd/Volts	GE 3ARR3	Mars		PTCR Starter
					6-Pak	OEM	
H23A263ABH	220/240-1-50	35/370	145-175/250	10AS	NA	NA	Optional
H23A283ABK	220/240-1-50	35/370	145-175/250	10AS	NA	NA	Optional
H23A303ABH	220/240-1-50	35/370	145-175/250	10AS	NA	NA	Optional
H23A323ABH	220/240-1-50	40/370	145-175/250	10AT	NA	NA	Optional
H23A353ABH	220/240-1-50	35/370	145-175/250	25AV	NA	NA	Optional
H23A35QABK	220/240-1-50	35/370	145-175/250	25AV	NA	NA	Optional
H23A383ABK	220/240-1-50	35/440	145-175/330	4AA	NA	NA	Optional
H23A38QABK	220/240-1-50	35/370	145-175/250	4AA	NA	NA	Optional
H23A423ABK	220/240-1-50	35/440	145-175/330	27AA	NA	NA	Optional
H23A42QABK	220/240-1-50	40/440	145-175/250	27AA	NA	NA	Optional
H23A463ABK	220/240-1-50	40/440	145-175/330	4AA	NA	NA	Optional
H23A46QABK	220/240-1-50	40/440	135-155/330	4AA	NA	NA	Optional

H23B SERIES 50 HZ

Compressor Model Number	Voltage Phase Hz.	Capacitors		Potential Relays			
		Run μ fd/Volts	Start μ fd/Volts	GE 3ARR3	Mars		PTCR Starter
					6-Pak	OEM	
H23B153ABH	220/240-1-50	25/370	88-108/250	10AS	NA	NA	Optional
H23B15QABH	220/240-1-50	20/370	88-108/250	10AS	NA	NA	Optional
H23B173ABH	220/240-1-50	25/370	88-108/250	10AS	NA	NA	Optional
H23B17QABH	220/240-1-50	25/370	88-108/250	10AS	NA	NA	Optional
H23B17SABH	220/240-1-50	30/370	145-175/250	10AS	NA	NA	Optional
H23B18SABH	220/240-1-50	30/370	145-175/250	10S	69	16067	Optional
H23B193ABK	220/240-1-50	30/370	88-108/250	10AS	NA	NA	Optional
H23B19QABK	220/240-1-50	30/370	88-108/250	10AS	NA	NA	Optional
H23B203ABK	220/240-1-50	30/370	88-108/250	25AS	NA	NA	Optional
H23B20QABK	220/240-1-50	30/370	88-108/250	25AS	NA	NA	Optional
H23B20SABH	220/240-1-50	35/370	145-175/250	10U	NA	NA	Optional
H23B223ABH	220/240-1-50	30/370	88-108/250	25AS	NA	NA	Optional
H23B22QABH	220/240-1-50	30/370	88-108/250	25AS	NA	NA	Optional
H23B22SABH	220/240-1-50	35/370	145-175/250	10U	NA	NA	Optional
H23B243ABK	220/240-1-50	35/440	88-108/250	10AS	NA	NA	Optional
H23B24QABK	220/240-1-50	35/440	88-108/250	10AS	NA	NA	Optional
H23B24SABH	220/240-1-50	35/370	145-175/250	10U	NA	NA	Optional
H23B263ABK	220/240-1-50	35/370	88-108/250	24AP	NA	NA	Optional
H23B26QABK	220/240-1-50	35/370	88-108/250	24AP	NA	NA	Optional
H23B26SABH	220/240-1-50	40/370	145-175/250	10S	69	16067	Optional
H23B283ABH	220/240-1-50	35/370	88-108/250	24AP	NA	NA	Optional
H23B28QABH	220/240-1-50	35/370	88-108/250	24AP	NA	NA	Optional
H23B28SABH	220/240-1-50	40/370	145-175/250	10S	69	16067	Optional

H23B SERIES 50 HZ (Continued)

Compressor Model Number	Voltage Phase Hz.	Capacitors		Potential Relays			
		Run μ fd/Volts	Start μ fd/Volts	GE 3ARR3	Mars		PTCR Starter
					6-Pak	OEM	
H23B303ABK	220/240-1-50	45/440	88-108/250	25AS	NA	NA	Optional
H23B30QABK	220/240-1-50	45/440	88-108/250	25AS	NA	NA	Optional
H23B30SABH	220/240-1-50	40/370	145-175/250	10S	69	16067	Optional
H23B323ABK	220/240-1-50	45/370	88-108/250	24AP	NA	NA	Optional
H23B33SABH	220/240-1-50	40/370	145-175/250	10S	69	16067	Optional
H23B35QABK	220/240-1-50	50/440	88-108/250	24R	NA	16057	Optional

H78A SERIES 50 HZ

Compressor Model Number	Voltage Phase Hz.	Capacitors		Potential Relays			
		Run μ fd/Volts	Start μ fd/Volts	GE 3ARR3	Mars		PTCR Starter
					6-Pak	OEM	
H78A423ABK	220/240-1-50	55/370	145-175/250	24P	69	16072	Optional

H79B SERIES 50 HZ

Compressor Model Number	Voltage Phase Hz.	Capacitors		Potential Relays			
		Run μ fd/Volts	Start μ fd/Volts	GE 3ARR3	Mars		PTCR Starter
					6-Pak	OEM	
H79B17UABH	220/240-1-50	30/370	145-175/250	10S	69	16067	Optional
H79B18UABH	220/240-1-50	30/370	145-175/250	10S	69	16067	Optional
H79B20UABH	220/240-1-50	30/370	145-175/250	10U	NA	NA	Optional
H79B22UABH	220/240-1-50	35/370	145-175/250	10U	NA	NA	Optional
H79B24UABK	220/240-1-50	35/370	145-175/250	10S	69	16072	Optional
H79B26UABK	220/240-1-50	40/370	145-175/250	10S	69	16072	Optional
H79B28UABK	220/240-1-50	40/370	145-175/250	3L	NA	16083	Optional
H79B30UABK	220/240-1-50	40/370	145-175/250	10S	69	16072	Optional
H79B32UABK	220/240-1-50	40/370	145-175/250	10S	69	16072	Optional
H79B33UABK	220/240-1-50	40/370	145-175/250	10S	69	16072	Optional
H79B35UABK	220/240-1-50	45/370	145-175/250	10S	69	16072	Optional

H89B SERIES 50 HZ

Compressor Model Number	Voltage Phase Hz.	Capacitors		Potential Relays			
		Run μ fd/Volts	Start μ fd/Volts	GE 3ARR3	Mars		PTCR Starter
					6-Pak	OEM	
H89B223ABH	220/240-1-50	40/370	161-193/250	10AS	NA	NA	Optional
H89B283ABH	220/240-1-50	40/370	189-227/250	10AT	NA	NA	Optional
H89B293ABH	220/240-1-50	40/370	189-227/250	10AT	NA	NA	Optional
H89B15UABH	220/240-1-50	30/320	216-259/250	10AA	NA	NA	Optional
H89B18UABH	220/240-1-50	30/320	216-259/250	10AA	NA	NA	Optional
H89B32UABH	220/240-1-50	45/370	270-324/250	10AU	NA	NA	Optional
H89B34UABH	220/240-1-50	45/370	270-324/250	10AU	NA	NA	Optional

H73B SERIES 50 HZ

Compressor Model Number	Voltage Phase Hz.	Capacitors		Potential Relays			
		Run μ fd/Volts	Start μ fd/Volts	GE 3ARR3	Mars		PTCR Starter
					6-Pak	OEM	
H73B17QABH	220/240-1-50	30/370	88-108/250	25AS	NA	NA	Optional
H73B19QABK	220/240-1-50	30/370	88-108/250	10AS	NA	NA	Optional
H73B20QABK	220/240-1-50	30/370	88-108/250	25AS	NA	NA	Optional
H73B22QABH	220/240-1-50	30/370	88-108/250	25AS	NA	NA	Optional
H73B24QABK	220/240-1-50	35/440	88-108/250	10AS	NA	NA	Optional
H73B26QABK	220/240-1-50	35/370	88-108/250	24AP	NA	NA	Optional
H73B28QABH	220/240-1-50	35/370	88-108/250	24AP	NA	NA	Optional
H73B30QABK	220/240-1-50	45/440	88-108/250	25AS	NA	NA	Optional
H73B32QABK	220/240-1-50	45/440	88-108/250	25AS	NA	NA	Optional
H73B35QABK	220/240-1-50	50/440	88-108/250	24R	NA	NA	Optional

PRESSURE-TEMPERATURE RELATION CHART

PSIG	TEMPERATURE °F						
	R-22	R-502	R-12	134a	R404A	R-407C	
					Saturated Vap/Liq.	Saturated Vapor	Saturated Liquid
5	-48	-57	-29	-22	-57	-41.0	-54.0
4	-47	-55	-28	-21	-56	-39.5	-52.6
3	-45	-54	-26	-19	-54	-38.1	-51.2
2	-44	-52	-25	-18	-53	-36.8	-49.8
1	-43	-51	-23	-16	-52	-35.5	-48.5
0	-41	-50	-22	-15	-50	-34.2	-47.2
1	-39	-47	-19	-12	-48	-31.8	-44.7
2	-44	-52	-25	-10	-46	-29.5	-42.3
3	-34	-42	-14	-8	-43	-27.2	-40.1
4	-32	-40	-11	-5	-41	-25.1	-37.9
5	-30	-38	-9	-3	-39	-23.1	-35.8
6	-28	-36	-7	-1	-37	-21.1	-33.8
7	-26	-34	-4	1	-35	-19.3	-31.9
8	-24	-32	-2	3	-33	-17.5	-30.1
9	-22	-30	0	5	-32	-15.7	-28.3
10	-20	-29	2	7	-30	-14.0	-26.6
11	-19	-27	4	8	-28	-12.4	-24.9
12	-17	-25	5	10	-27	-10.8	-23.3
13	-15	-24	7	12	-25	-9.2	-21.7
14	-14	-22	9	13	-23	-7.7	-20.1
15	-12	-20	11	15	-22	-6.3	-18.6
16	-11	-19	12	16	-20	-4.8	-17.2
17	-9	-18	14	18	-19	-3.5	-15.8
18	-8	-16	15	19	-18	-2.1	-14.4
19	-7	-15	17	21	-16	-0.8	-13.0
20	-5	-13	18	22	-15	0.5	-11.7
21	-4	-12	20	24	-14	1.8	-10.4
22	-3	-11	21	25	-12	3.0	-9.2
23	-1	-9	23	26	-11	4.2	-7.9
24	0	-8	24	27	-10	5.4	-6.7
25	1	-7	25	29	-9	6.6	-5.5
26	2	-6	27	30	-8	7.7	-4.3
27	4	-5	28	31	-6	8.9	-3.2
28	5	-3	29	32	-5	10.0	-2.1
29	6	-2	31	33	-4	11.0	-1.0
30	7	-1	32	35	-3	12.1	0.1
31	8	0	33	36	-2	-13.2	1.2
32	9	1	34	37	-1	14.2	2.2
33	10	2	35	38	0	15.2	3.3
34	11	3	37	39	1	16.2	4.3
35	12	4	38	40	2	17.2	5.3
36	13	5	39	41	3	18.1	6.3
37	14	6	40	42	4	19.1	7.2
38	15	7	41	43	5	20.0	8.2
39	16	8	42	44	6	20.9	9.1
40	17	9	43	45	7	21.8	10.1
42	19	11	45	47	8	23.6	11.9
44	21	13	47	49	10	25.4	13.6
46	23	15	49	51	12	27.1	15.4
48	24	16	51	52	14	28.7	17.0
50	26	18	53	54	16	30.3	18.7
52	28	20	55	56	17	31.9	20.3
54	29	21	57	57	19	33.4	21.9

PSIG	TEMPERATURE °F						
	R-22	R-502	R-12	134a	R404A	R-407C	
					Saturated Vap/Liq.	Saturated Vapor	Saturated Liquid
56	31	23	58	59	20	34.9	23.4
58	32	24	60	60	22	36.4	24.9
60	34	26	62	62	23	37.8	26.3
62	35	27	64	64	25	39.2	27.8
64	37	29	65	65	26	40.6	29.2
66	38	30	67	66	27	42.0	30.6
68	40	32	68	68	29	43.3	31.9
70	41	33	70	69	30	44.6	33.3
72	42	34	71	71	32	45.9	34.6
74	44	36	73	72	33	47.8	36.5
76	45	37	74	73	34	48.4	37.1
78	46	38	76	75	35	49.6	38.4
80	48	40	77	76	37	50.8	39.6
85	51	43	81	79	40	53.7	42.6
90	54	46	84	82	42	56.5	45.4
95	56	49	87	85	45	59.2	48.2
100	59	51	90	88	48	61.8	50.9
105	62	54	93	90	50	64.3	53.5
110	64	57	96	93	52	66.7	56.0
115	67	59	99	96	55	69.1	58.4
120	69	62	102	98	57	71.4	60.8
125	72	64	104	100	59	73.6	63.0
130	74	67	107	103	62	75.8	65.3
135	76	69	109	105	64	77.9	67.5
140	78	71	112	107	66	80.0	69.6
145	81	73	114	109	68	82.0	71.7
150	83	75	117	112	70	83.9	73.7
155	85	77	119	114	72	85.8	75.7
160	87	80	121	116	74	87.7	77.6
165	89	82	123	118	76	89.5	79.5
170	91	83	126	120	78	91.3	81.3
175	92	85	128	122	80	93.1	83.2
180	94	87	130	123	82	94.8	84.9
185	96	89	132	125	83	96.5	86.7
190	98	91	134	127	85	98.1	88.4
195	100	93	136	129	87	99.8	90.1
200	101	95	138	131	88	101.4	91.8
205	103	96	140	132	90	102.9	93.4
210	105	98	142	134	92	104.5	95.0
220	108	101	145	137	95	107.4	98.1
230	111	105	149	140	98	110.3	101.1
240	114	108	152	143	101	113.1	104.1
250	117	111	156	146	104	115.9	106.9
260	120	114	159	149	107	118.5	109.7
275	124	118	163	153	111	122.3	113.7
290	128	122	168	157	115	126.0	117.6
305	132	126	172	161	118	129.5	121.3
320	136	130	177	165	122	132.9	124.9
335	139	133	181	169	126	136.2	128.4
350	143	137	185	172	129	139.4	131.8
365	146	140	188	176	132	142.5	135.0

NOTE: FOR R-407C:

To determine superheat, use saturated vapor values (small figures)
 To determine subcooling, use saturated liquid values (BOLD figures)

*Inches of Mercury

To convert °F to °C: $(°F - 32) \div 1.8 = °C$

PED LABEL INFORMATION

Explanation of the European Pressure Equipment Directive (PED) label information (if the compressor is PED-approved):

- The first five digits of the 11-digit serial number give the manufacture and leak test date of the compressor. The first three digits represent the day of the year (for example: 059 = February 28). The next two digits represent the year (for example: 02 = 2002).
- PS is the maximum allowable pressure
- PT is the leak test pressure
- TS (max) is the maximum design temperature
- TS (min) is the minimum design temperature

PART NO. 707318-1000-01
MODEL NO. H79A423DBVA OC-5
(S)07102019725



(P)707318-1000-01



V~460/380 HZ 60 PH 3 LRA 64	V~380/415 HZ 50 PH 3 LRA 67
-----------------------------------	-----------------------------------

CE THERMALLY PROTECTED 0871

MADE IN USA

PS=18.5 bar TS(max) = 43 C REFRIGERANTS:
PT=20.7 bar TS(min) = -40 C FLUID GROUP 2 ONLY

COMPRESSOR MODEL NUMBER SYSTEM

